

**B2 CABINET - LED LIGHTING**

ELECTRICAL CONTRACTOR TO SUPPLY AND INSTALL LIGHTING

SUPPLIER: TREND LIGHTING  
 ORDER CODE: XF24120B3-EXM  
 DESCRIPTION: 5 x 1740mm LONG, 24V 8W/m LOW WATTAGE LED STRIP, 3000K  
 c/w ALUMINIUM MAGNETIC EXTRUSION, OPAL DIFFUSER, LED DRIVER, 3m LEAD

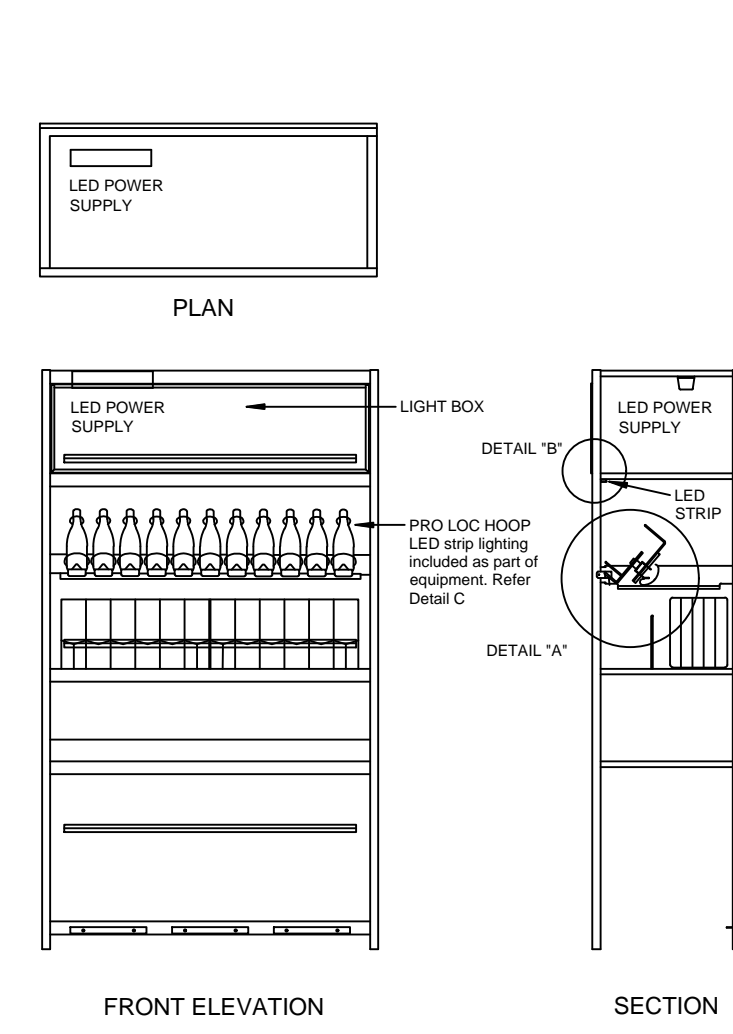

**M WALL BAYS - WOTW - LED LIGHTING**

ELECTRICAL CONTRACTOR TO SUPPLY AND INSTALL LIGHTING

SUPPLIER: TREND LIGHTING  
 ORDER CODE: XF24120B3-EXM  
 DESCRIPTION: 1 x 1240mm LONG, 24V 8W/m LOW WATTAGE LED STRIP, 3000K  
 c/w ALUMINIUM MAGNETIC EXTRUSION, OPAL DIFFUSER, LED DRIVER, 3m LEAD

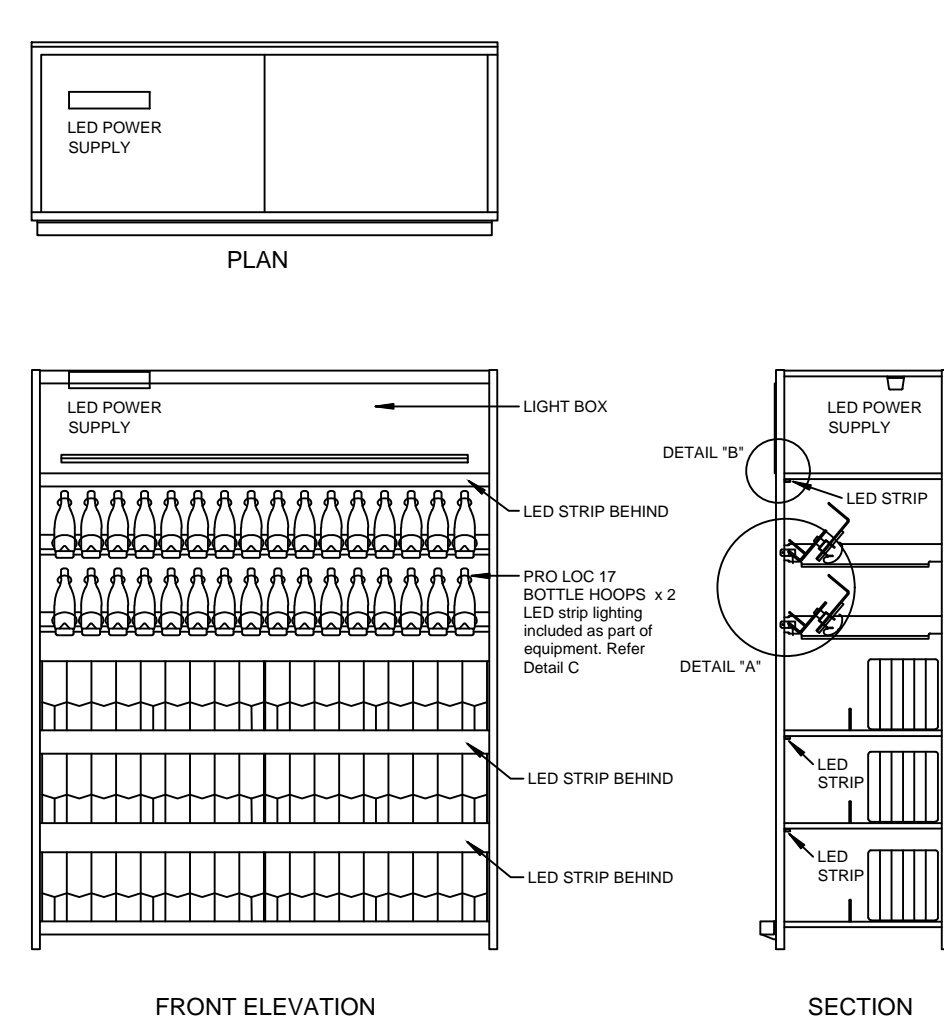

**B28 CABINET - LED LIGHTING**

ELECTRICAL CONTRACTOR TO SUPPLY AND INSTALL LIGHTING

SUPPLIER: TREND LIGHTING  
 ORDER CODE: XF24120B3-EXM  
 DESCRIPTION: 3 x 1740mm LONG, 24V 8W/m LOW WATTAGE LED STRIP, 3000K  
 c/w ALUMINIUM MAGNETIC EXTRUSION, OPAL DIFFUSER, LED DRIVER, 3m LEAD

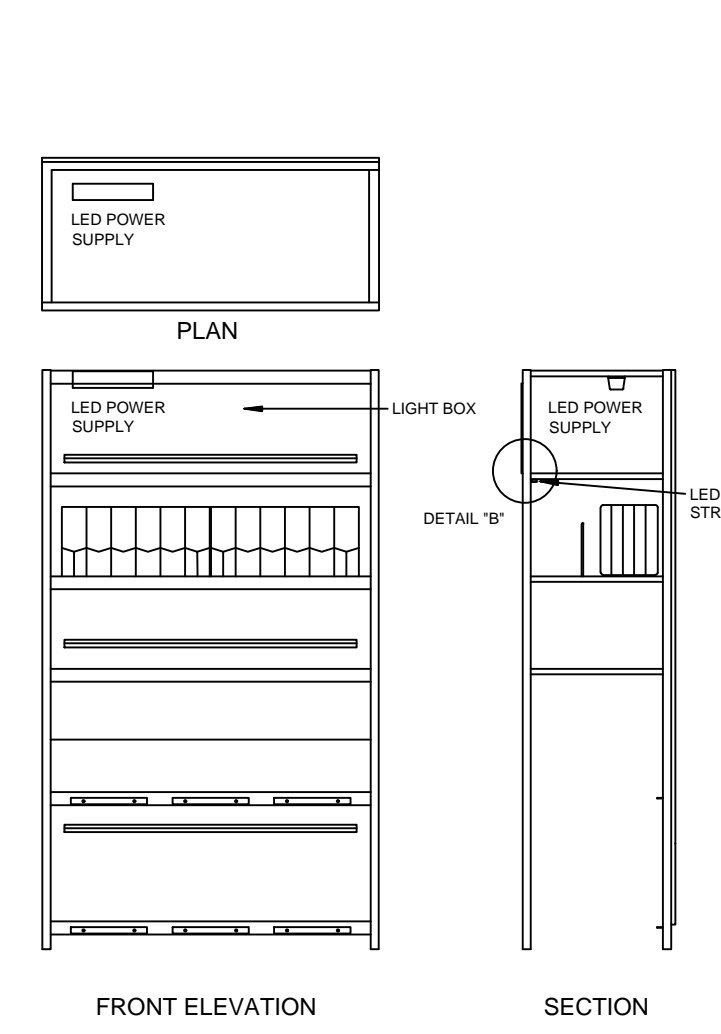

**M WALL BAYS - LED LIGHTING**

ELECTRICAL CONTRACTOR TO SUPPLY AND INSTALL LIGHTING

SUPPLIER: TREND LIGHTING  
 ORDER CODE: XF24120B3-EXM  
 DESCRIPTION: 1 x 1240mm LONG, 24V 8W/m LOW WATTAGE LED STRIP, 3000K  
 c/w ALUMINIUM MAGNETIC EXTRUSION, OPAL DIFFUSER, LED DRIVER, 3m LEAD

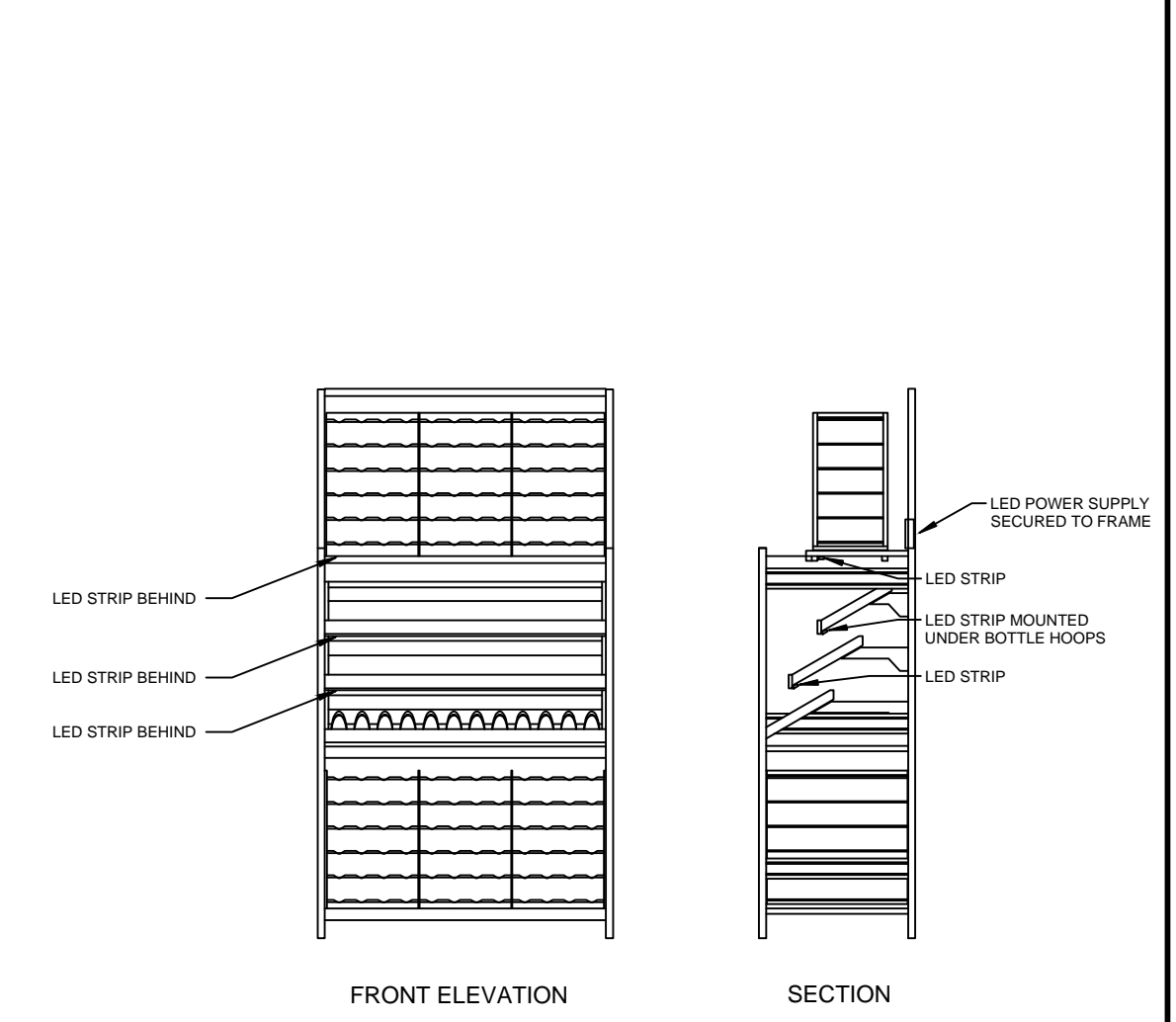

**FINE WINE SECURITY WALL BAY - TYPE B**

ELECTRICAL CONTRACTOR TO SUPPLY AND INSTALL LIGHTING

SUPPLIER: TREND LIGHTING  
 ORDER CODE: XF24120B3-EXM  
 DESCRIPTION: 3 x 1240mm LONG, 24V 8W/m LOW WATTAGE LED STRIP, 3000K  
 c/w ALUMINIUM MAGNETIC EXTRUSION, OPAL DIFFUSER, LED DRIVER, 3m LEAD

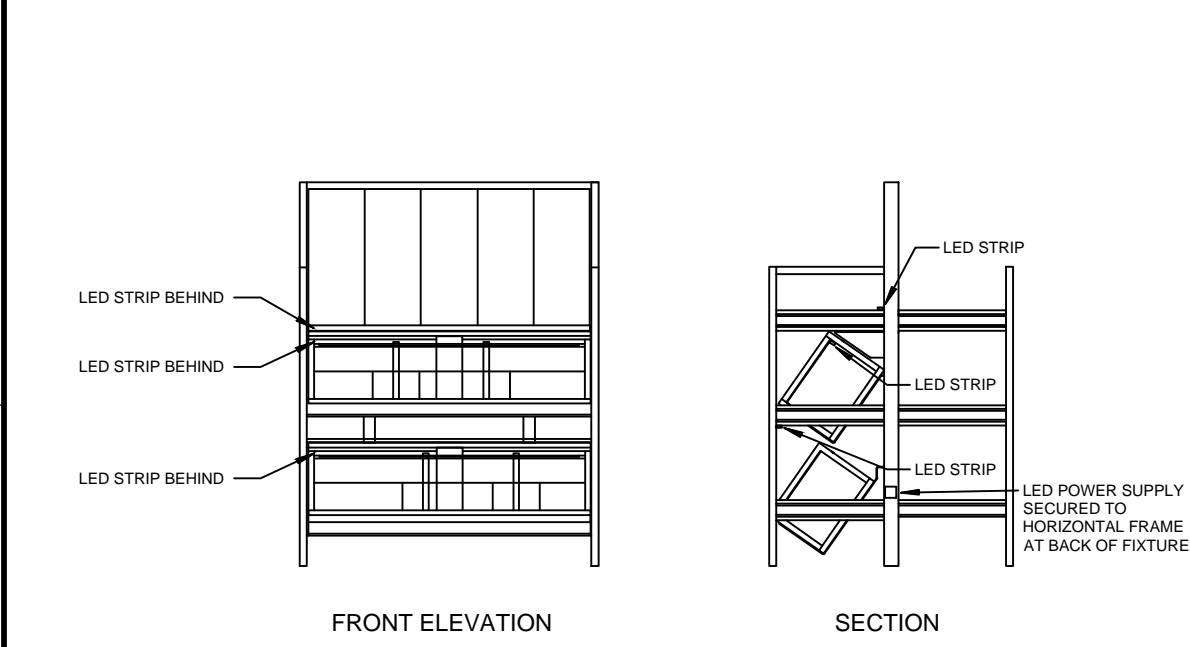

**CELLAR RELEASE BAY**

CABINET MANUFACTURER TO SUPPLY LIGHTS, INSTALLATION BY ELECTRICAL CONTRACTOR

SUPPLIER: TREND LIGHTING  
 ORDER CODE: XF24120B3-EXM  
 DESCRIPTION: 3 x 1240mm LONG, 24V 8W/m LOW WATTAGE LED STRIP, 3000K  
 c/w ALUMINIUM MAGNETIC EXTRUSION, OPAL DIFFUSER, LED DRIVER, 3m LEAD

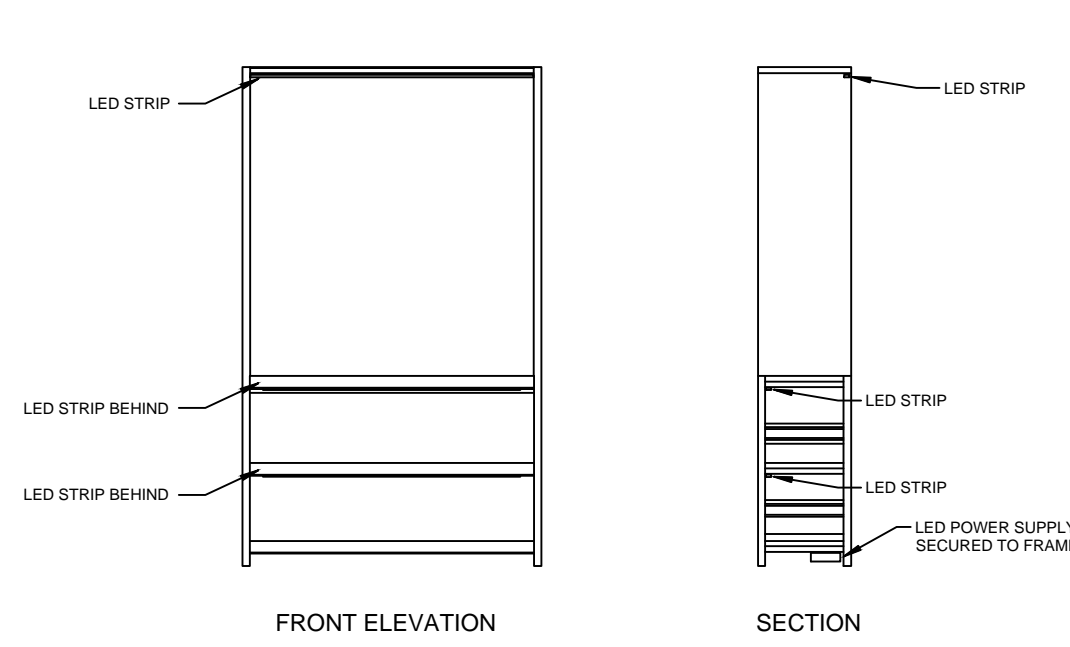

**MID FLOOR WARDROBE BAY**

CABINET MANUFACTURER TO SUPPLY LIGHTS, INSTALLATION BY ELECTRICAL CONTRACTOR

SUPPLIER: TREND LIGHTING  
 ORDER CODE: XF24120B3-EXM  
 DESCRIPTION: 3 x 1240mm LONG, 24V 8W/m LOW WATTAGE LED STRIP, 3000K  
 c/w ALUMINIUM MAGNETIC EXTRUSION, OPAL DIFFUSER, LED DRIVER, 3m LEAD

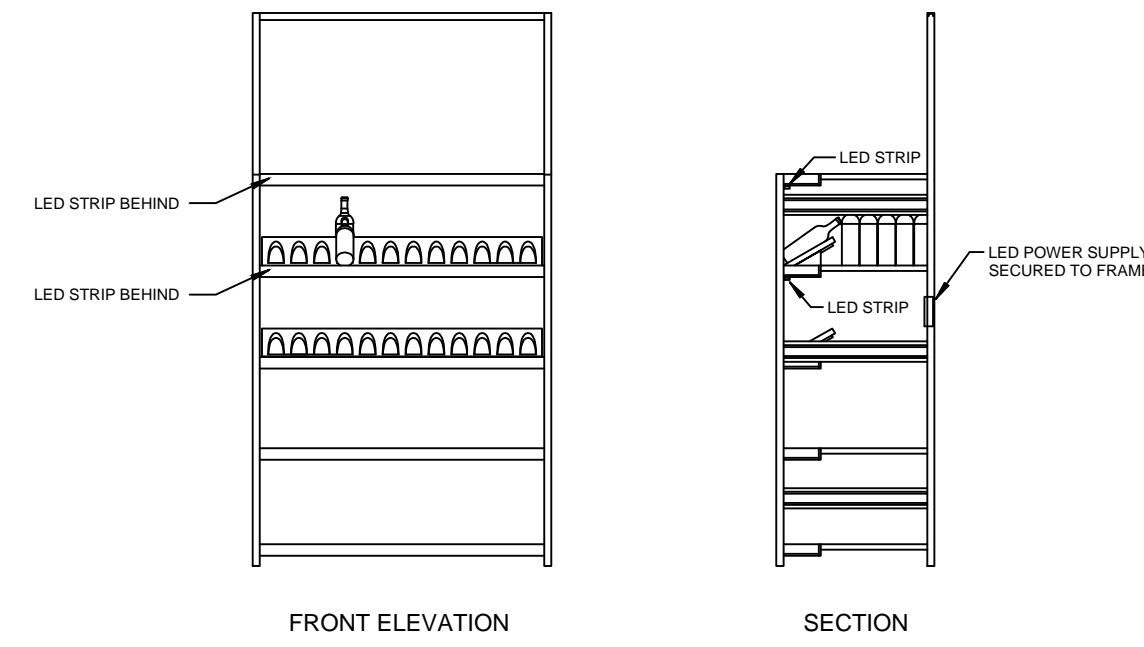

**FINE WINE WALL BAY - TYPE A**

ELECTRICAL CONTRACTOR TO SUPPLY AND INSTALL LIGHTING

SUPPLIER: TREND LIGHTING  
 ORDER CODE: XF24120B3-EXM  
 DESCRIPTION: 2 x 1180mm LONG, 24V 8W/m LOW WATTAGE LED STRIP, 3000K  
 c/w ALUMINIUM MAGNETIC EXTRUSION, OPAL DIFFUSER, LED DRIVER, 3m LEAD

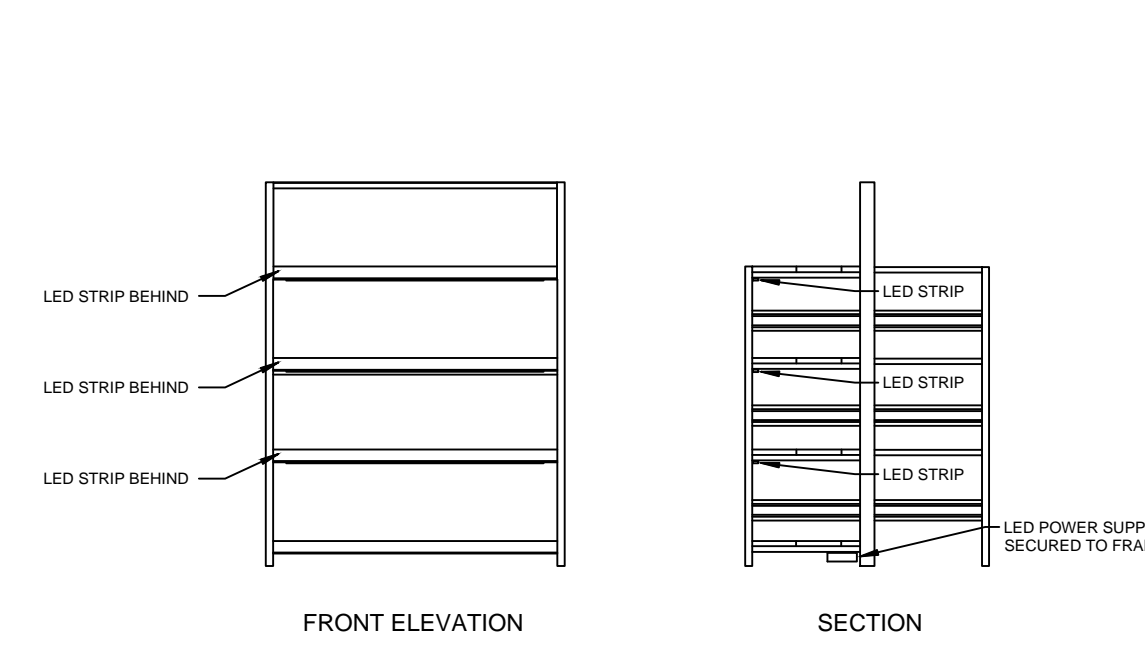

**COCKTAIL MIXOLOGY BAY**

CABINET MANUFACTURER TO SUPPLY LIGHTS, INSTALLATION BY ELECTRICAL CONTRACTOR

SUPPLIER: TREND LIGHTING  
 ORDER CODE: XF24120B3-EXM  
 DESCRIPTION: 3 x 1180mm LONG, 24V 8W/m LOW WATTAGE LED STRIP, 3000K  
 c/w ALUMINIUM MAGNETIC EXTRUSION, OPAL DIFFUSER, LED DRIVER, 3m LEAD

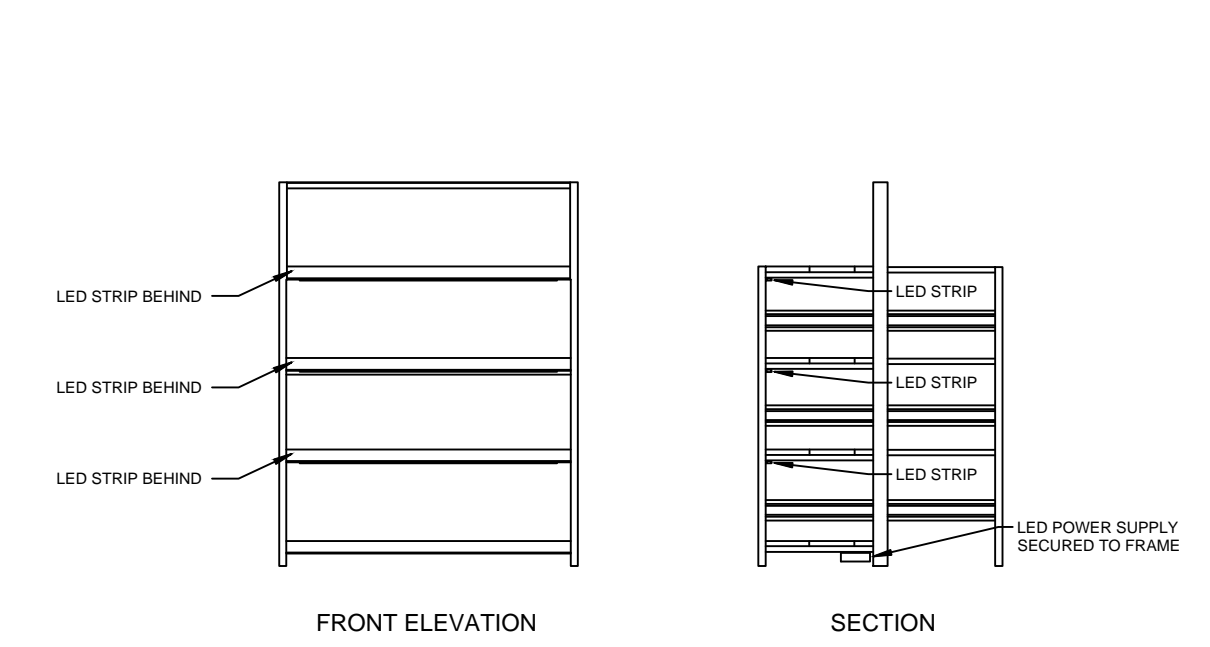

**GIN BAY**

ELECTRICAL CONTRACTOR TO SUPPLY AND INSTALL LIGHTING

FOR 2.0 DAN MURPHY'S STORE:  
 3000K LED LIGHTING  
 SUPPLIER: TREND LIGHTING  
 ORDER CODE: XF24120B3-EXM  
 DESCRIPTION: 3 x 1240mm LONG, 24V 8W/m LOW WATTAGE LED STRIP, 3000K  
 c/w ALUMINIUM MAGNETIC EXTRUSION, OPAL DIFFUSER, LED DRIVER, 3m LEAD

FOR STANDARD DAN MURPHY'S STORE:  
 CYAN LED LIGHTING  
 SUPPLIER: TREND LIGHTING  
 ORDER CODE: XF24120B3-EXM  
 DESCRIPTION: 3 x 1240mm LONG, 24V 8W/m LOW WATTAGE LED STRIP, CYAN  
 c/w ALUMINIUM MAGNETIC EXTRUSION, OPAL DIFFUSER, LED DRIVER, 3m LEAD

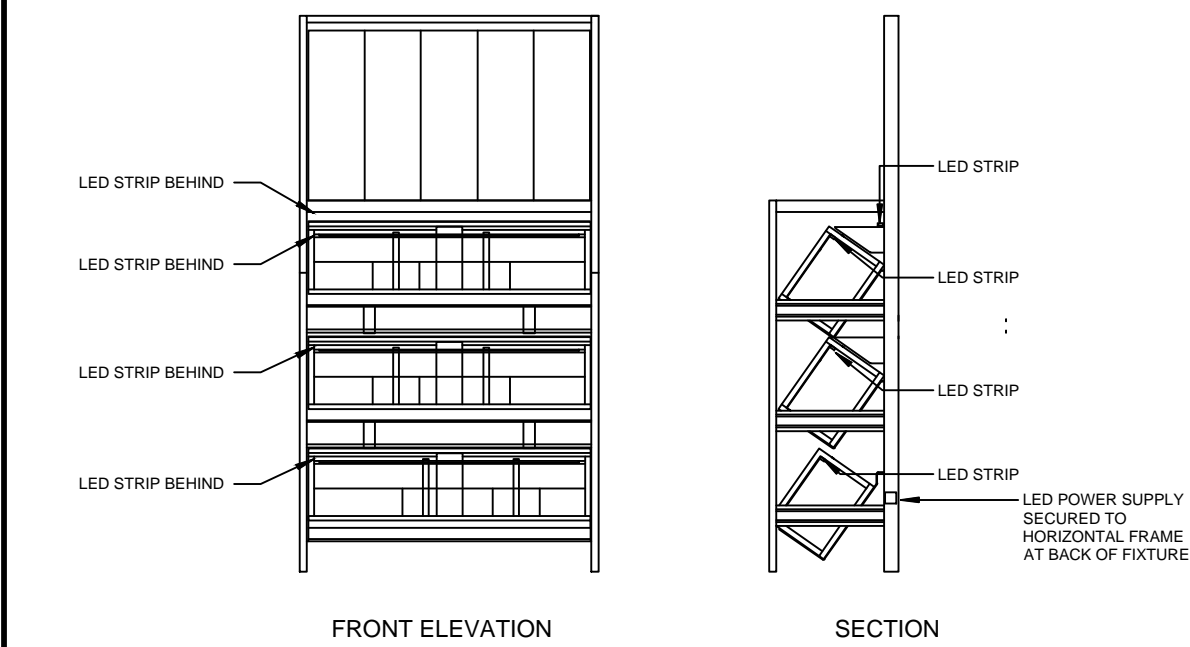

**CELLAR RELEASE - WALL BAY**

CABINET MANUFACTURER TO SUPPLY LIGHTS, INSTALLATION BY ELECTRICAL CONTRACTOR

SUPPLIER: TREND LIGHTING  
 ORDER CODE: XF24120B3-EXM  
 DESCRIPTION: 4 x 1240mm LONG, 24V 8W/m LOW WATTAGE LED STRIP, 3000K  
 c/w ALUMINIUM MAGNETIC EXTRUSION, OPAL DIFFUSER, LED DRIVER, 3m LEAD

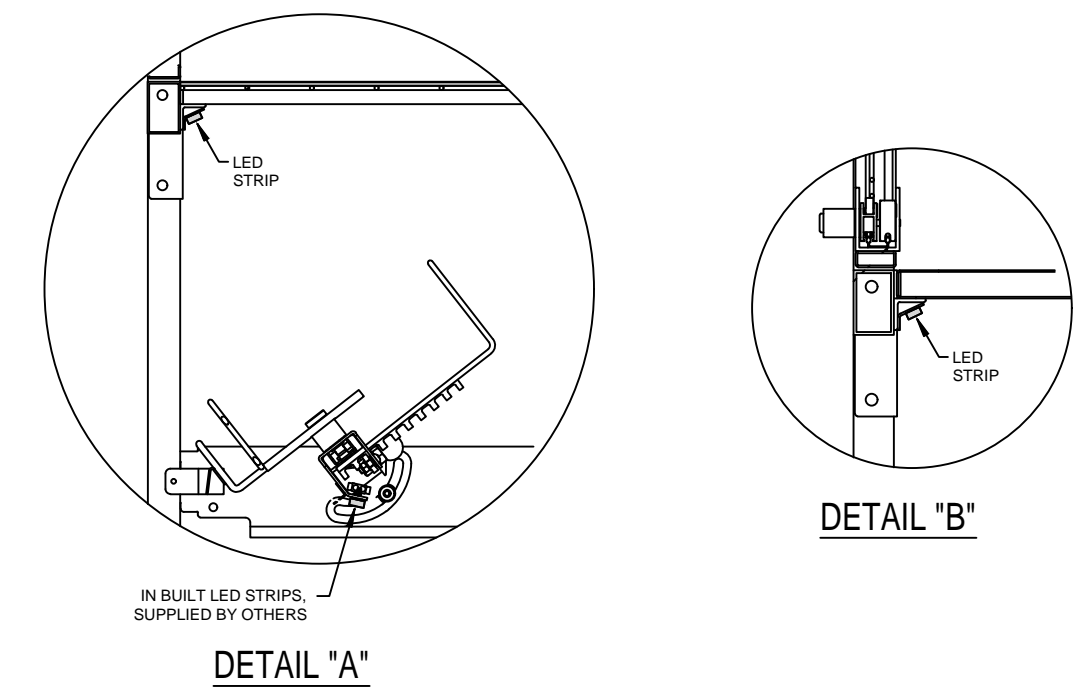
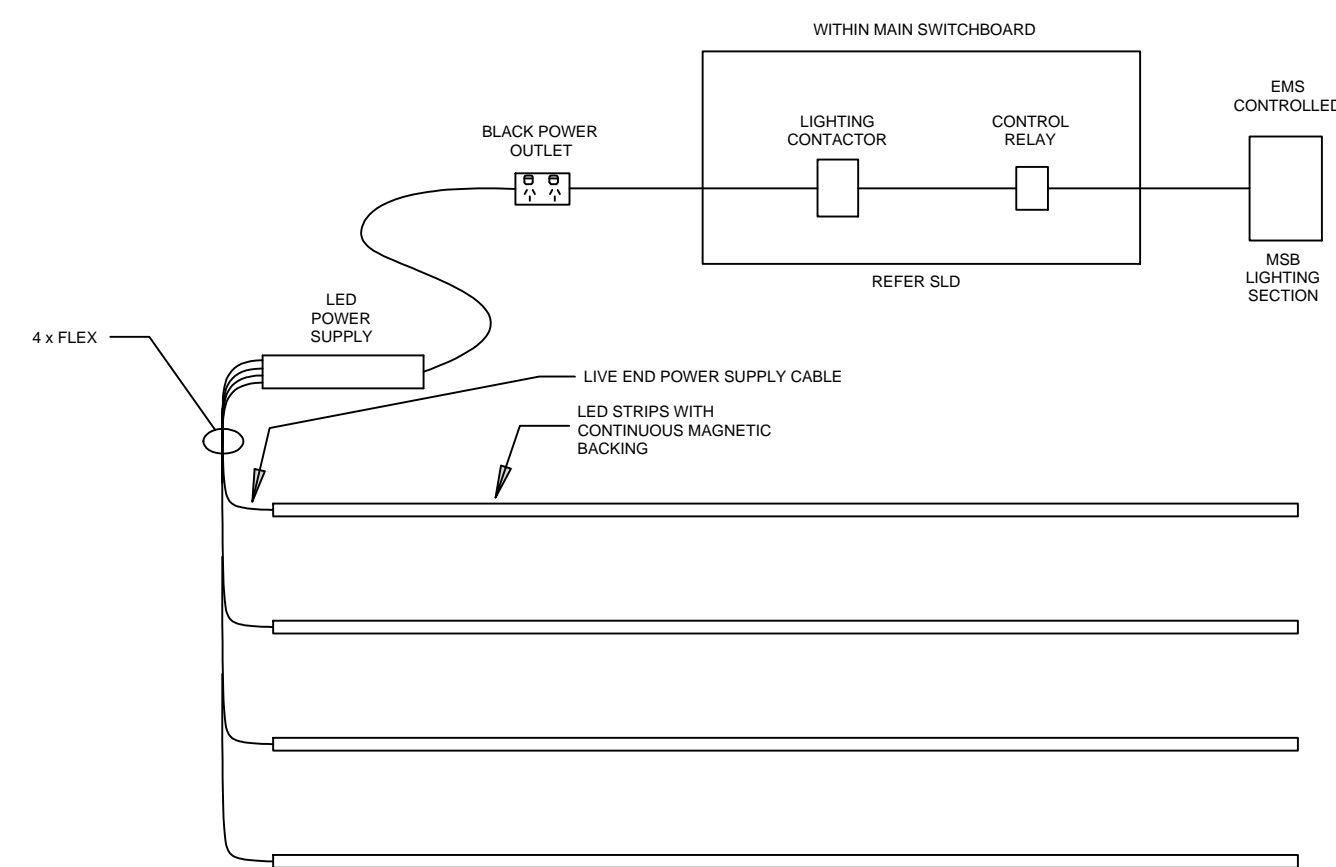

**GENERAL NOTES**

1. ELECTRICAL CONTRACTOR TO SUPPLY AND / OR INSTALL UNDERSHELF LED STRIP LIGHTS AS DETAILED FOR EACH CABINET TYPE. INCLUDED IN THE SCOPE IS THE PROVISION OF POWER OUTLETS FOR UNDERSHELF LIGHTS.
2. REFER STORE SPECIFIC ARCHITECTURAL DRAWINGS FOR CABINET TYPES AND QUANTITIES REQUIRED.

ELECTRICAL DESIGN GROUP BRISBANE PTY LTD  
 ACN 092 710 793  
 TRADING AS:  
 ELECTRICAL DESIGN GROUP

THE COPYRIGHT OF THIS DRAWING REMAINS THE PROPERTY OF THE ELECTRICAL DESIGN GROUP.  
 USE FIGURED DIMENSIONS IN PREFERENCE TO SCALE.  
 ALL DIMENSIONS TO BE VERIFIED ONSITE.

**ELECTRICAL DESIGN GROUP**  
 ELECTRICAL BUILDING SERVICES CONSULTANTS  
 BRISBANE GOLD COAST  
 P.O. Box 15, Sherwood Q.4075  
 Phone: (07) 3278 4375  
 Email: brisbane@edg.net.au  
 Web: www.edg.net.au

PROJECT:  
**PALM BEACH DAN MURPHYS**  
 118 GOLD COAST HIGHWAY, PALM BEACH, GOLD COAST

B	TENDER	19/06/2023
REV:	DESCRIPTION:	DATE:
DRAWING: <b>ELECTRICAL SERVICES</b> <b>DAN MURPHY'S LED CABINET LIGHTS</b>		
SCALE: NOT TO SCALE AT A1	PROJECT NO: <b>C2582a</b>	DRAWING NO: <b>E08</b>
		REVISION: <b>B</b>